

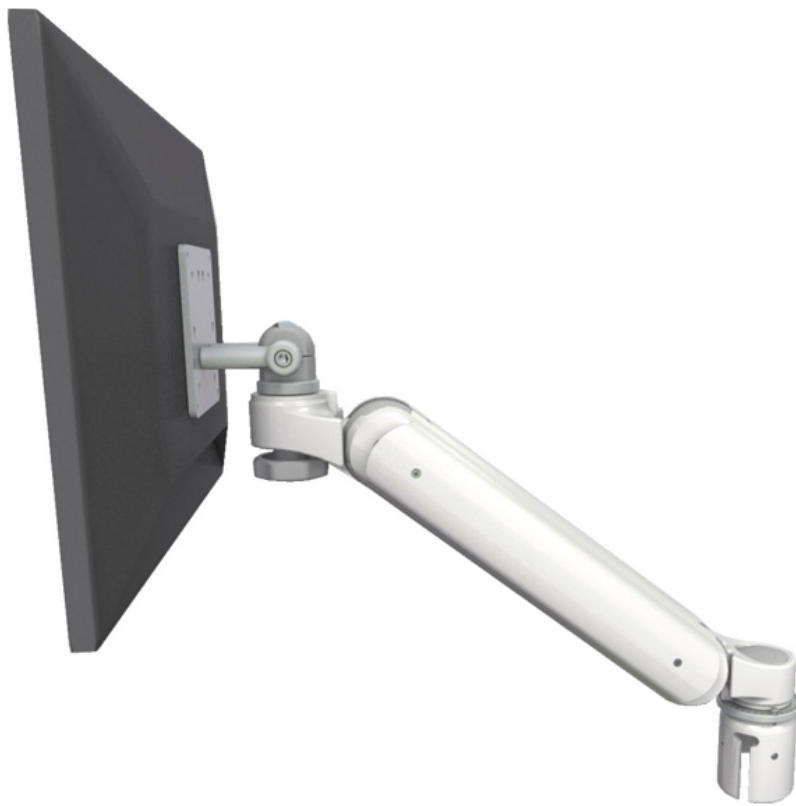







# Ultra 182 EV65 Monitor Dental Radius Mount

Specification Sheet



-  Up to 556mm
-  Up to 556mm
-  +/- 90°
-  +/- 90°
-  Yes
-  13.6Kg
-  75 x 75  
100 x 100

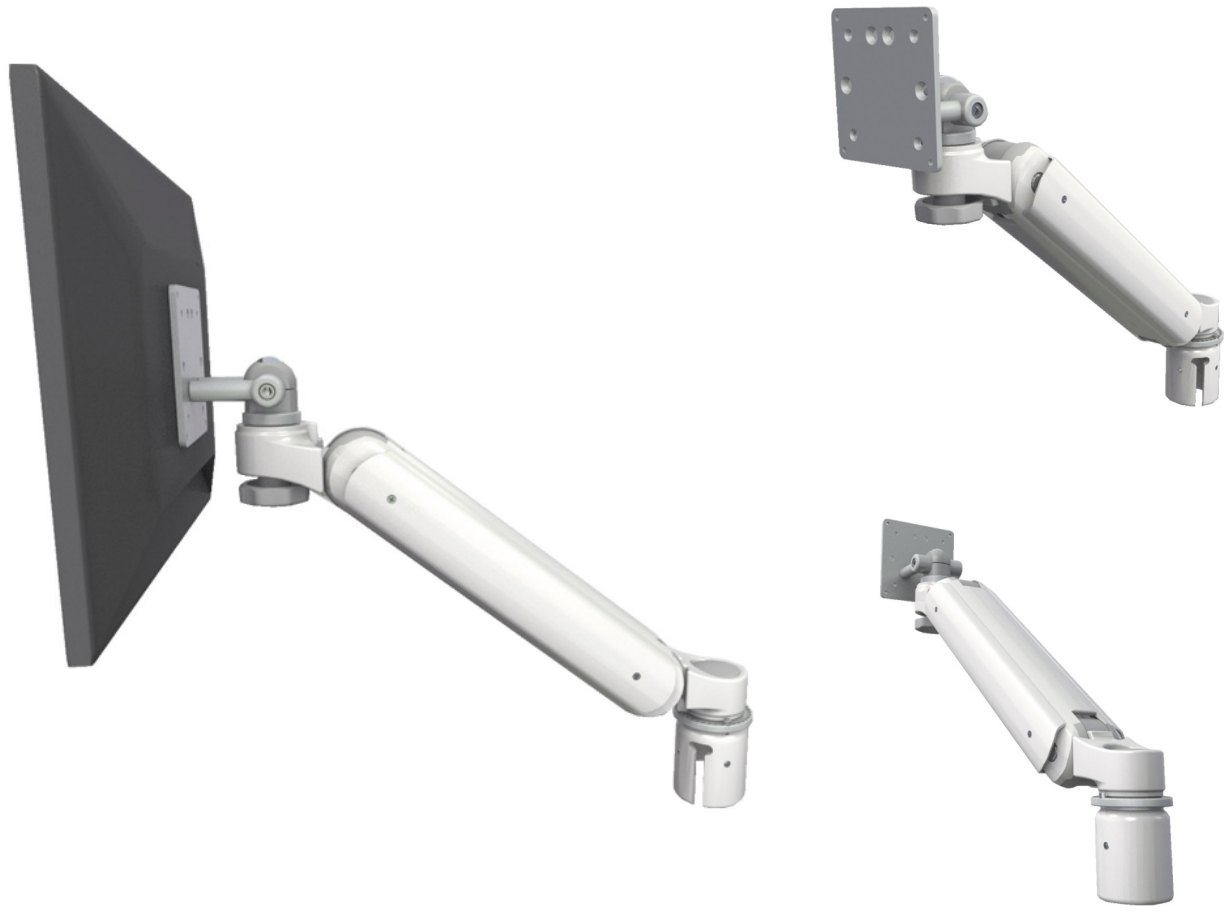

- Medical grade solution.
- Supports Monitors 13.6Kg.
- Compact but adjustable.
- Billet Aluminium construction.
- Can be cleaned with “Hospital Grade” solutions (10,000 parts bleach per 1,000,000).

The ErgoMounts Ultra 182 EV65 Dental Radius mount allows you to secure to a screen or TV to the top of a 2” diameter pole on a gas assisted monitor arm. This makes them ideal for mounting onto existing healthcare equipment like dental chairs. With a weight capacity of 13.6Kg this mount can easily hold most modern LED or LCD Monitors provided they are VESA 75mm x 75mm or VESA 100mm x 100mm compliant, if you’re unsure whether this mount is going to be compatible with your monitor or equipment please contact us or your nearest ErgoMounts representative for more information. This arm provides a minimum of 556mm built in gas assisted height adjustment, 75° tilt and 360° of rotation. When not in use the Ultra 182 EV65 Radius Mount can be stowed just 74mm (3”) away from the mounting point.

This unique and patent pending arm is fully counter balanced, making lifting or lowering your keyboard or monitor effortless. Although originally designed to fit onto dental chairs and orthodontic equipment our range of medical radius mounts are suitable to mount on to any 2” (51mm) diameter poles. Each of these mounts are built out of billet aluminium and powder coated for a durable finish.

They can be wiped clean with hospital grade solutions (10,000 parts bleach per 1,000,000) making them also ideal for areas where they are going to be exposed to large amounts of dirt and dust such as workshops and production lines.

**Ideal For**



**Healthcare**



**Education**



**Manufacturing**



**Commercial**

**Manufactured to order...**

All of our Medical Grade Mounting Solutions are manufactured to order by our partners in the United States. These are then air freighted to us before being hand inspected and assembled by our talented team of technicians at our headquarters in Hampshire, United Kingdom. This allows us to offer 100’s of combinations on our products as well as bespoke design but at a much shorter lead time to our competitors who often rely on Far East manufacturing.



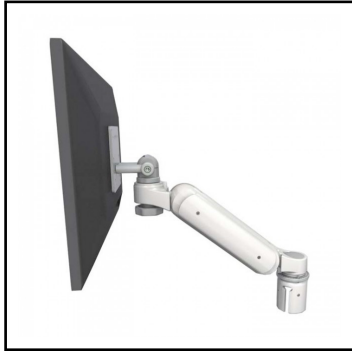

**EMUL182EV6-R2-MW**

Ultra 182 EV65  
2" Dental Radius Mount  
Compact  
Medical White

**EMUL182EV6-R2-QG**

Ultra 182 EV65  
2" Dental Radius Mount  
Compact  
Light Grey



**EMUL182EV6-R2-TB**

Ultra 182 EV65  
2" Dental Radius Mount  
Compact  
Black

## Range of motion:

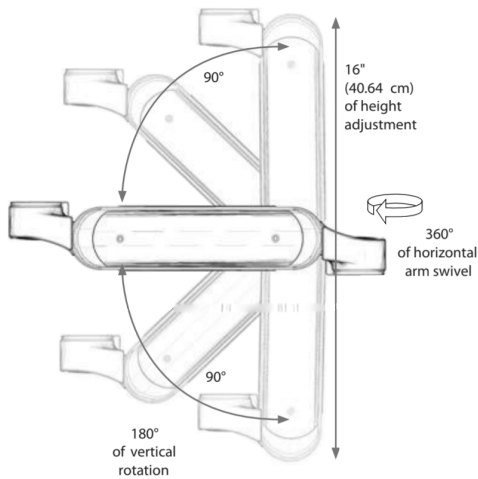

## Installation & Maintenance

The ErgoMounts Planned Preventative Maintenance Programme (PPM) covers bi-annual visits from one of our highly trained technicians. They ensure all of our arms are working as intended and replace or repair any worn parts. This often extends the working life of the mounts by several years resulting in significant savings. Contact us to find out more about our installation and maintenance plans.





## Interested In Selling Our Products?

We're always looking for new businesses to take on and sell our exciting portfolio of products. Our resellers receive a range of exclusive benefits including combined marketing, trade accounts and access to our team of experts.

For more information contact: [info@ergomounts.co.uk](mailto:info@ergomounts.co.uk)



 Unit 10 Pegasus Court, North Lane, Aldershot,  
Hampshire, England, United Kingdom

 +44 (0) 1252 333 326

 [sales@ergomounts.co.uk](mailto:sales@ergomounts.co.uk)

 [www.ergomounts.co.uk](http://www.ergomounts.co.uk)

