

Ultra 182i Inverted Monitor Wall Mount

Specification Sheet



- 
Up to
1205mm
- 
405mm
- 
+/- 90°
- 
+/- 180°
- 
Yes
- 
14.5Kg
- 
75 x 75
100 x 100



Ideal For



Healthcare



Education



Manufacturing



Commercial

- Medical grade solution.
- Supports Monitor & Keyboard combinations up to 14.5Kg.
- Can be folded away when not in use.
- Full 360 ° of swivel.
- Billet Aluminium construction.
- Can be cleaned with “Hospital Grade” solutions (10,000 parts bleach per 1,000,000).

The ErgoMounts Ultra 182i Monitor Wall Mount is an innovative solution to the sit-stand workstation. Offering full articulation of your monitor while supporting up to 14.5 kg. This unique and patent pending arm is fully counter balanced, making lifting or lowering your monitor effortless. This arm provides 180° of vertical arm rotation and up to 360° of horizontal rotation. The Ultra 182 stows close to the wall, making it the perfect choice for tight spaces. Cable channelling through the arm assembly. Engineered for years of reliable service and quiet operation.

This mount can support 99.9% of screens with either a VESA 75mm x 75mm or VESA 100mm x 100mm interface plate and weighing less than 14.5Kg.

Manufactured to order...

All of our Medical Grade Mounting Solutions are manufactured to order by our partners in the United States. These are then air freighted to us before being hand inspected and assembled by our talented team of technicians at our headquarters in Hampshire, United Kingdom. This allows us to offer 100's of combinations on our products as well as bespoke design but at a much shorter lead time to our competitors who often rely on Far East manufacturing.





EMUL182IEV7-W3-MW

Ultra 182i Inverted
Compact Wall Mount
Medical White



EMUL182IEV7-W3-QG

Ultra 182i Inverted
Compact Wall Mount
Light Grey

EMUL182IEV7-W3-TB

Ultra 182i Inverted
Compact Wall Mount
Black



EMUL182IEV7-W3-A1-MW

Ultra 182i Inverted
Extended Wall Mount
Medical White



EMUL182IEV7-W3-A1-QG

Ultra 182i Inverted
Extended Wall Mount
Light Grey

EMUL182IEV7-W3-A1-TB

Ultra 182i Inverted
Extended Wall Mount
Black

Arm Comparison:

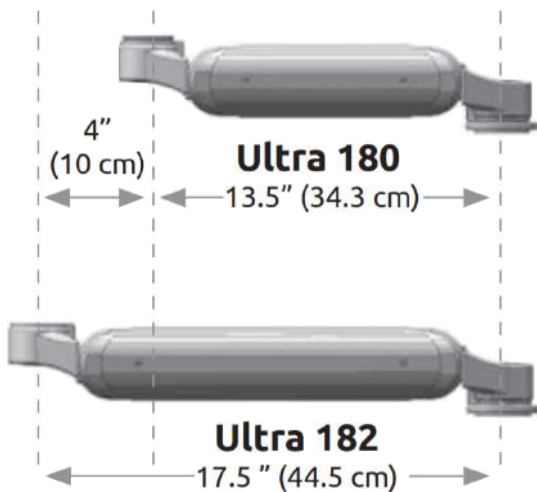

Installation & Maintenance

The ErgoMounts Planned Preventative Maintenance Programme (PPM) covers bi-annual visits from one of our highly trained technicians. They ensure all of our arms are working as intended and replace or repair any worn parts. This often extends the working life of the mounts by several years resulting in significant savings. Contact us to find out more about our installation and maintenance plans.





Interested In Selling Our Products?

We're always looking for new businesses to take on and sell our exciting portfolio of products. Our resellers receive a range of exclusive benefits including combined marketing, trade accounts and access to our team of experts.

For more information contact: info@ergomounts.co.uk



 Unit 10 Pegasus Court, North Lane, Aldershot,
Hampshire, England, United Kingdom

 +44 (0) 1252 333 326

 sales@ergomounts.co.uk

 www.ergomounts.co.uk

